

BULLDOG

INSTRUCTIONS FOR USE

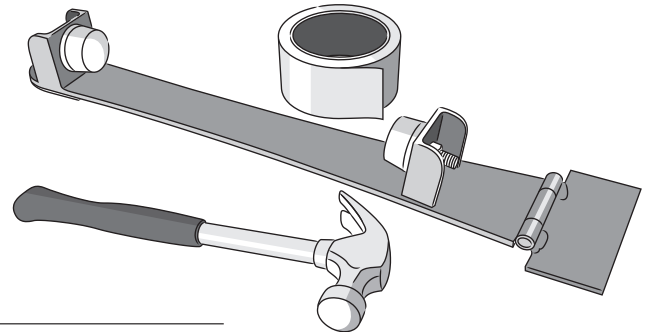

Please read all instructions before you begin.

YOU WILL NEED

- Parky Bulldog
- Parky double-faced tape
- Hammer

HOW DO YOU WORK

1. Vacuum the floor thoroughly to remove any dust or dirt (dust or dirt may prevent the tool from adhering to the surface of the planks).
2. Mark the plank(s) you want to replace with an X.
3. Cut one piece of double-faced tape (approximately 18 cm/7 inch long) and wrap it around the hinged end of the Bulldog tool.
4. Remove the protective paper from the tape (leaving part of the protective paper will allow for adjustments to different width planks).
5. Adhere the Bulldog to the plank closest to Wall C (plank 1), on the row with the marked plank, by placing one foot on top of the hinged section, and tap the tool so that the plank slides towards the wall until it unlocks from the rest of the row. To disengage the tool from the plank, raise the tool on the hinge and, carefully, rock it from side to side.

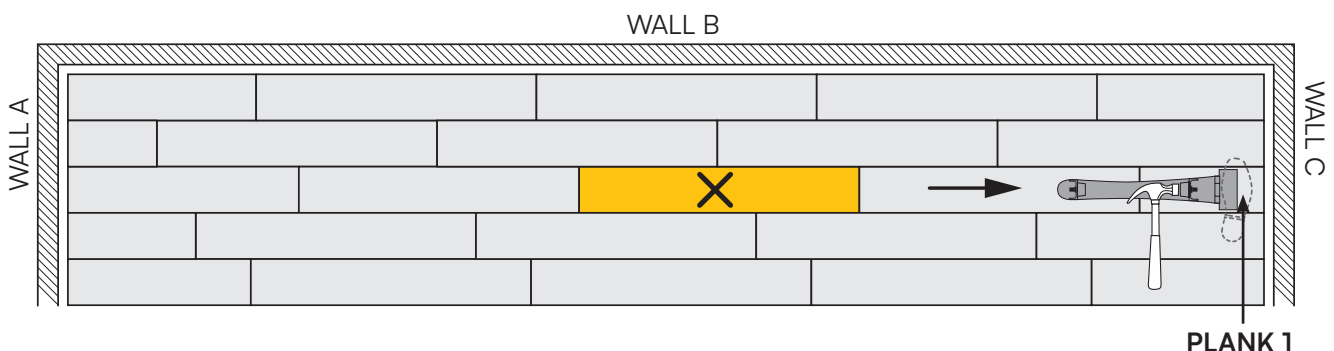
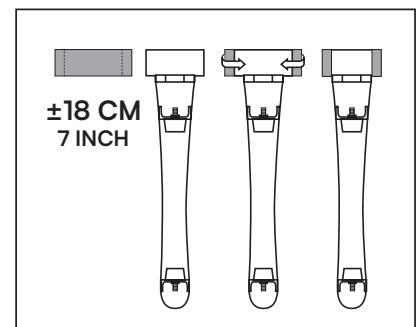

6. Continue in the same method, unlocking planks on that row, until you reach the damaged plank.
7. Repeat steps # 5 and 6, starting at Wall A (other side of the damaged plank).

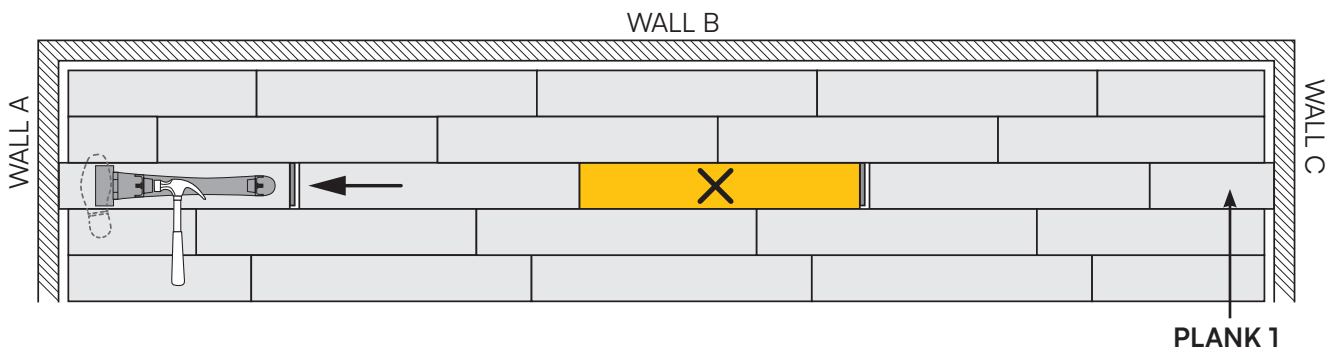

8. Now, to unlock the long side of the planks: Return to the row beside the damaged plank, and starting near Wall C, attach the tool to Plank 2 as close to the wall as possible and tap the tool towards Wall B (closest wall) until the two planks partially disengage. Repeat along this row every 30 cm/12 inch until the long side of the damaged plank is totally exposed.

The side of the plank you are trying to release is the tongue side, as it will require a smaller gap to remove it from the floor than the groove side — you can identify which long side has the tongue as soon as you unlock the short sides in step #5.

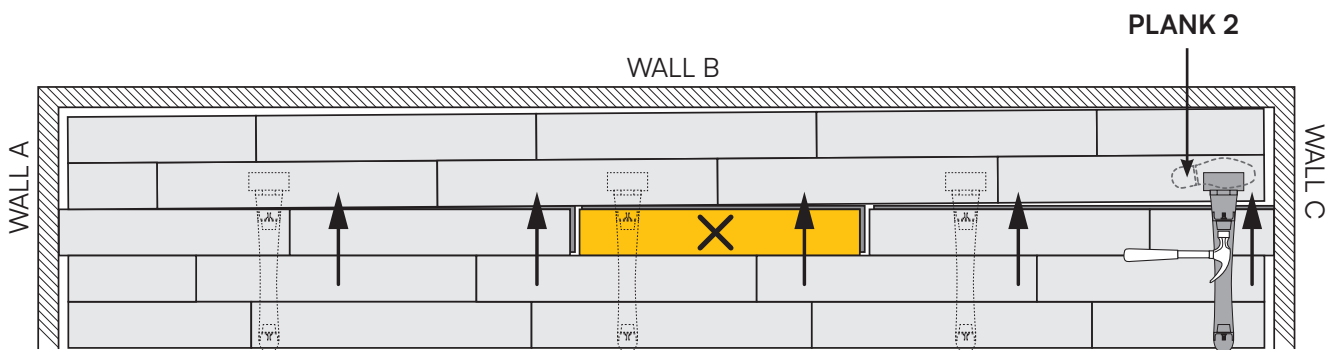

9. Remove the damaged plank and click the new plank into place. Lock together the short sides of the replaced plank, continuing along the full row until all short sides are re-engaged.

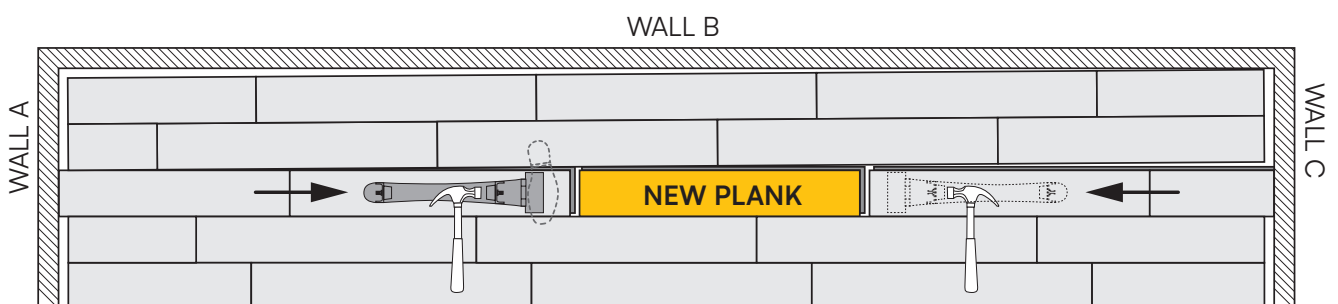

10. Next, re-engage all the long sides, starting by the planks nearest to Wall A. The repair is complete when all joints are re-engaged.

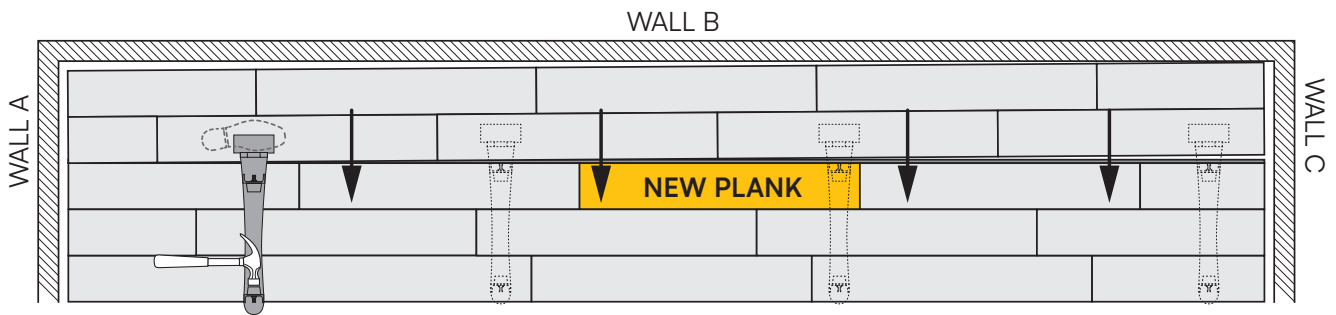

IMPORTANT INFORMATION:

The Parky Bulldog tool is designed to work with all Parky floors except the Swing collection.

Parky has selected the best available double-faced tape for use with the Bulldog. Any residue left on the surface of the floor, may be removed with rubbing alcohol; paint thinner will remove adhesive residue but leave a film on the surface of the floor.

The Parky Bulldog is a tapping tool and as such, use only minimum necessary force required to click or unclick planks. Tap one plank into place at a time. We do not recommend tapping/moving full rows.

When using the Parky Bulldog for closing open joints, first ensure joints are open enough so you can remove any dirt that might have collected. Close the joints only after joints are clean.

Success of the replacement will depend on how well the floor was initially installed with proper expansion around the perimeter.

The weight of the floor, furniture and the baseboards will limit the amount of floor that can be moved at one time. Split the floor into “moveable” sections for larger areas.



If you have any questions, don't hesitate to contact your local dealer or the head office in Belgium.

Decospan nv, Industriezone Grensland
Lageweg 33, 8930 Menen - Belgium
tel +32 56 52 88 49 - info@par-ky.com
www.par-ky.com

DECOSPAN®